

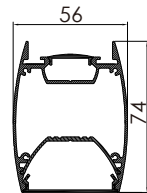

Feature

- Professional appearance design, simple and elegant.
- High quality, energy-efficient LED Lighting for environmental protection.
- Anodized aluminum profile with good heat sink.
- Built-in power supply, no flicker.
- For offices, conference rooms, supermarkets, home lighting, etc.



Customizable size

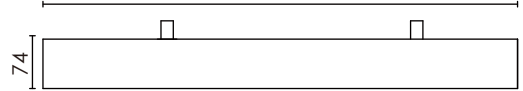

Luminaire parameters

Size	L2000*W56*H74mm
Lm	(up)2250lm*(down)4050lm
Input Voltage	AC100-240V
Beam Angle	270°
Nominal Power	(up)25W(down)45W
CCT	2700-6500k
CRI	>80
Protection Grade	IP40
Certification	CE, RoHS
Warranty	3 years

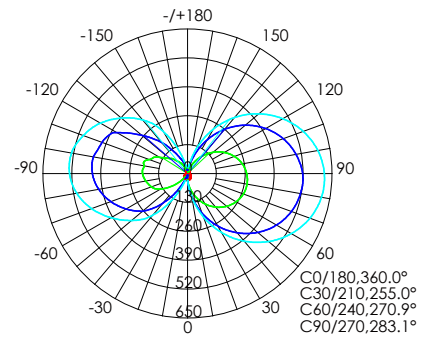

Height	Eavg, Emax	Diameter
1m	63.86, 199.3lx	319.32cm
2m	15.97, 49.82lx	638.64cm
3m	7.096, 22.14lx	957.97cm
4m	3.992, 12.45lx	1277.29cm
5m	2.555, 7.97lx	1596.61cm

Note: The curve is the illumination area and the average illuminance of the luminaire under different projection distances.

Installation Accessories



Suspended Rope



Connector



Aluminum Profile

Installation

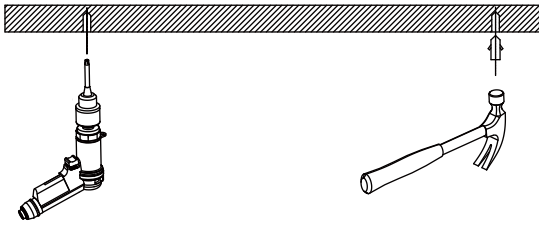

① Prepare the electric drill, hammer, stud;

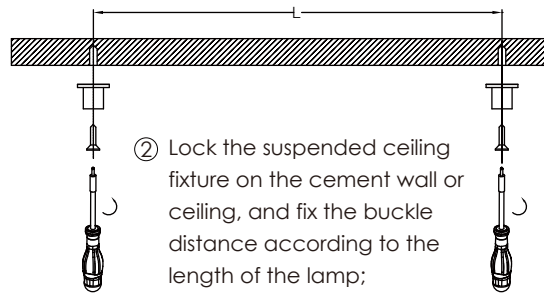

② Lock the suspended ceiling fixture on the cement wall or ceiling, and fix the buckle distance according to the length of the lamp;

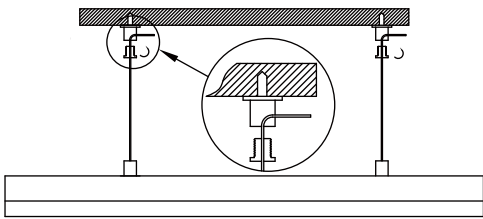

③ Lock the wire sling fixing parts, and fixed the installation length by adjust the wire sling;

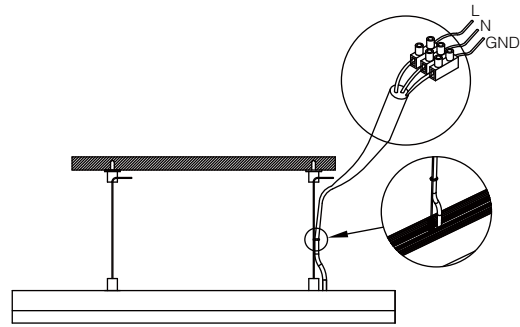

④ Connect the power supply and complete the installation.

Packing

① Fill in pearly cotton

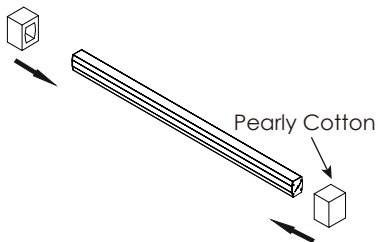

② Packing

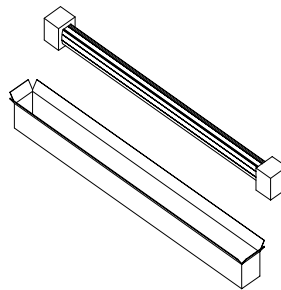

③ Sealing

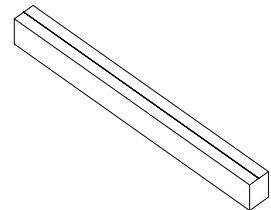

Model	HL-CA001-L20	Carton box	2067*407*271mm
Inner box	2052*98*128mm	QTY/Carton	8 PCS

Notices

- 1.The power supply must be turned off before installation.
- 2.Make sure the product is mounted under the surface of the object to be installed, and finally turn on the power to light up.
- 3.This product is for indoor use only.
- 4.This product is warranted for 3 years and problems occur within 3 years (except for human factors and accidental factors), free maintenance.
- 5.The product is not responsible for damage caused by accidental factors or improper use.