

UGR<19



Feature

- Combination and splicing are simple, and installation is convenient, both vertically and horizontally;
- The size is large and the lighting is sufficient;
- Professional anti-glare prism diffuser plate, anti-glare value UGR<19, soft and comfortable light, protect eyes;
- Applications: Offices, conference rooms, supermarkets, schools, home lighting, etc.

Luminaire parameters

Model	HL-PA085-L02
Size	L200*W200*H40mm
Nominal Power	12W
Lm	600lm
Input Voltage	AC90-264V
Beam Angle	110°-120°
CCT	2700-6500k
CRI	>80
Protection Grade	IP40
Certification	CE, RoHS
Warranty	3 years

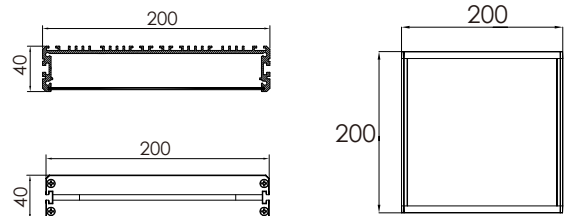
Unit: mm

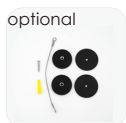

Installation Accessories

 optional
 Magnetic surface mounting

 optional
 Suspended installation

Connector

Installation- suspended installation

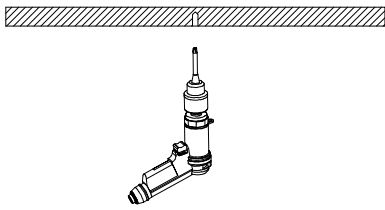

① Drilling holes in the ceiling.

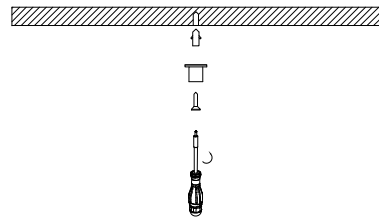

② Insert the plastic wall plug into the hole and lock the fixed end of the sling.

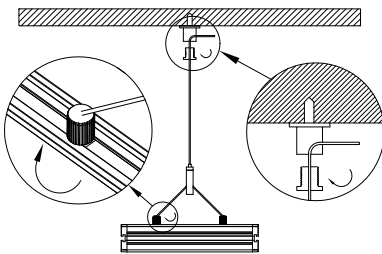

③ Screw one end of the hanging rope splitter into the T-nut on the lamp, and screw the other end of the hanging rope into the ceiling to lock it.

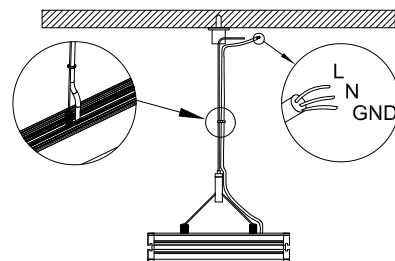

④ Bundle the input line and the hanging rope together and connect to the mains electricity.

Installation- magnetic surface mounting

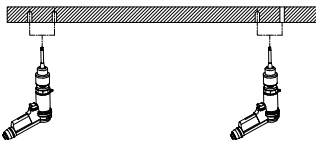

① Drilling holes in the ceiling.

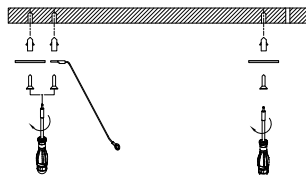

② Insert the plastic wall plug into the hole and lock the iron sheet and the secure steel wire rope.

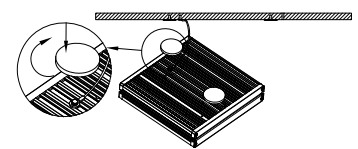

③ Lock the secure steel wire rope under the magnet.

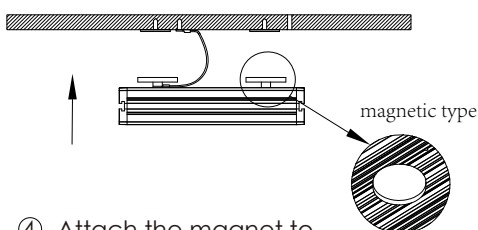

④ Attach the magnet to the iron sheet.

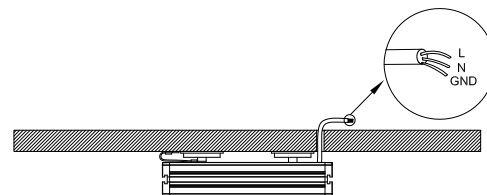

⑤ Access to mains electricity

Packing

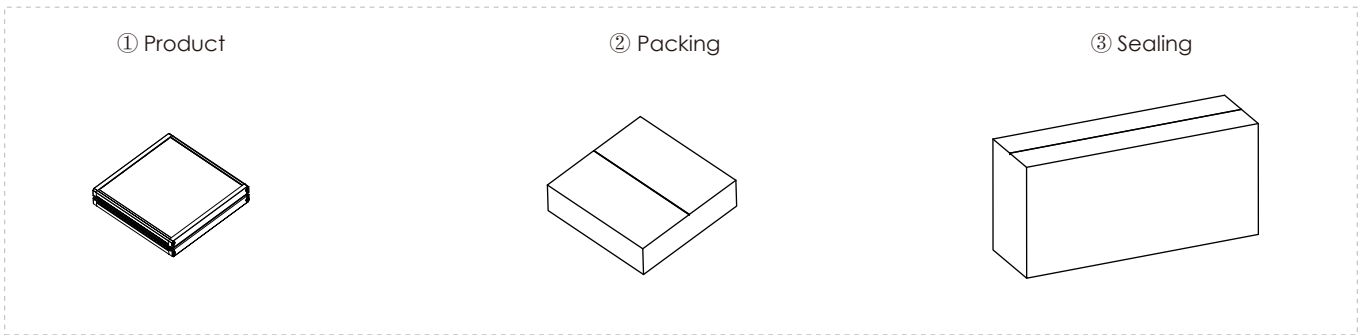

Model	Inner box	Carton box	QTY/Carton
HL-PA085-L02	285*255*65mm	880*270*415mm	18PCS

Spliceable

First, put the lamps together, and then insert the H-shaped profile strips into the slots; To fix it, insert the connecting piece between the two lamps, and then lock the screws with a small wrench.

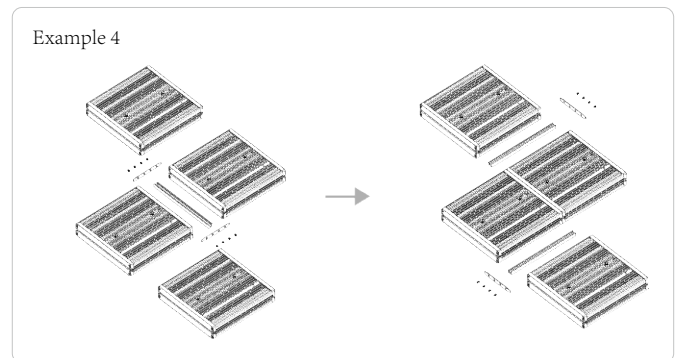
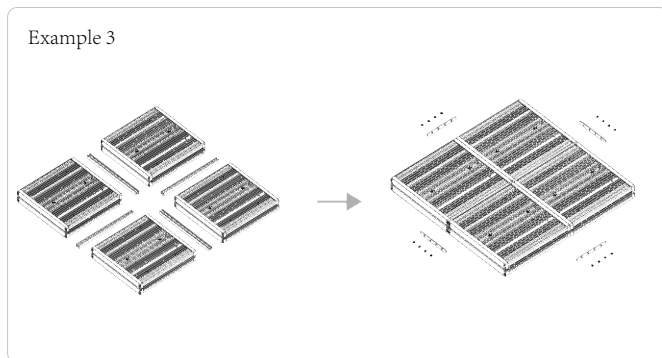
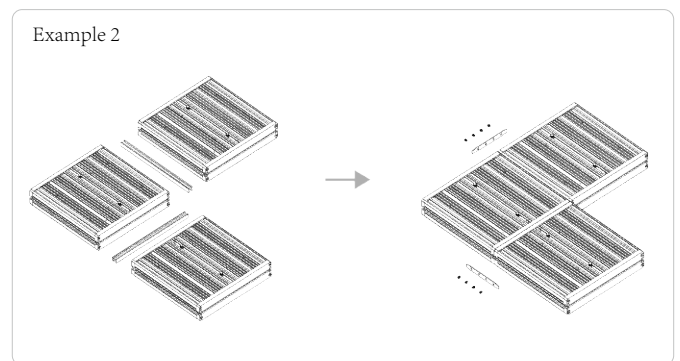
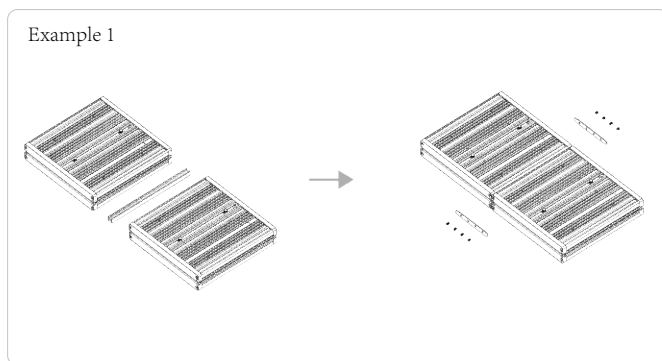

Notices

1. The power supply must be turned off before installation.
2. Make sure the product is mounted under the surface of the object to be installed, and finally turn on the power to light up.
3. This product is for indoor use only.
4. This product is warranted for 3 years and problems occur within 3 years (except for human factors and accidental factors), free maintenance.
5. The product is not responsible for damage caused by accidental factors or improper use.