

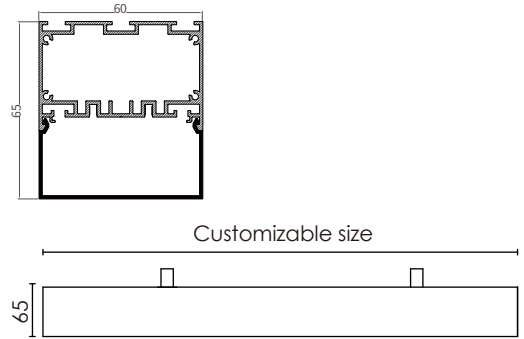

Feature

- Professional appearance design, simple and elegant.
- High quality, energy-efficient LED Lighting for environmental protection.
- Anodized aluminum profile with good heat sink.
- External power supply, no flicker.
- For offices, conference rooms, supermarkets, home lighting, etc.



Luminaire parameters

Size	L1200*W60*H65mm
Lm	7500lm
Input Voltage	AC100-240V
Beam Angle	120°
Nominal Power	50W
CCT	2700-6500k
CRI	>80
Protection Grade	IP40
Certification	CE, ROHS
Warranty	3 years

Installation Accessories



Suspended Rope



Connector



Aluminum Profile

Installation

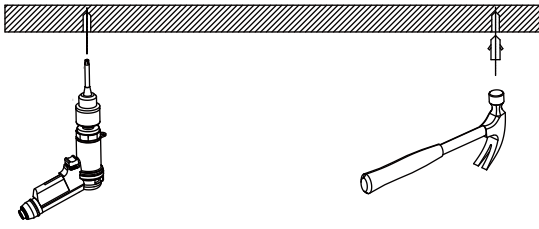

① Prepare the electric drill, hammer, stud;

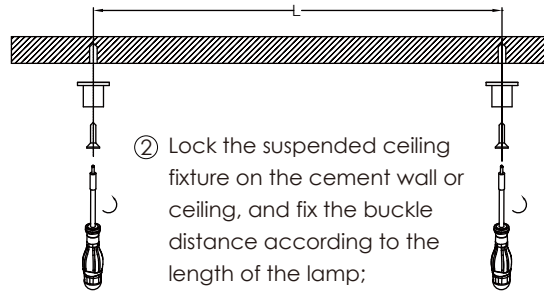

② Lock the suspended ceiling fixture on the cement wall or ceiling, and fix the buckle distance according to the length of the lamp;

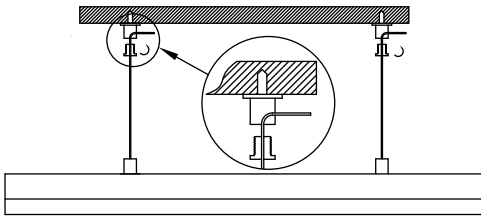

③ Lock the wire sling fixing parts, and fixed the installation length by adjust the wire sling;

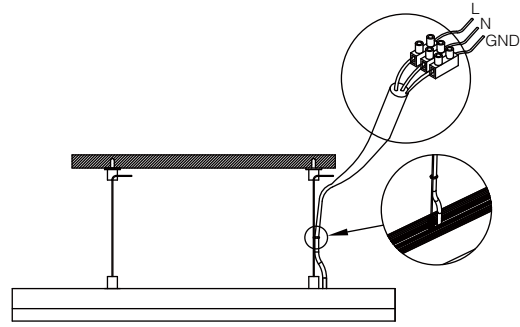

④ Connect the power supply and complete the installation.

Packing

① Product

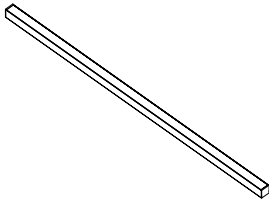

② Packing

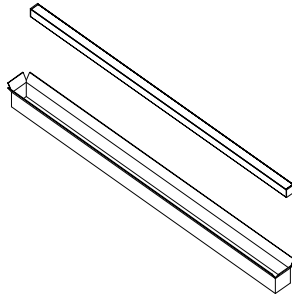

③ Sealing

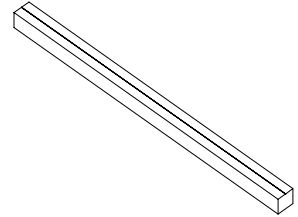

Model	HL-CB6065-L12	Carton box	L1240*W400*H400mm
Inner box	L1230*W95*H95mm	QTY/Carton	8 PCS

Notices

- 1.The power supply must be turned off before installation.
- 2.Make sure the product is mounted under the surface of the object to be installed, and finally turn on the power to light up.
- 3.This product is for indoor use only.
- 4.This product is warranted for 3 years and problems occur within 3 years (except for human factors and accidental factors), free maintenance.
- 5.The product is not responsible for damage caused by accidental factors or improper use.