

### Feature

- Sharp lines, simple appearance.
- High quality LED, High luminous efficiency.
- Anodized aluminum profile with good heat sink.
- Build-in power driver.
- For offices, conference rooms, supermarkets, home lighting, etc.

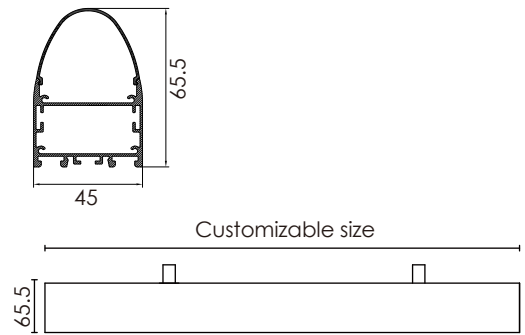

Luminaire parameters	
Size	L1200*W45*H65.5mm
Lm	2200lm
Input Voltage	AC100-240V
Beam Angle	120°
Nominal Power	22W
CCT	2700-6500k>
CRI	80
Protection Grade	IP40
Certification	CE, Ro HS
Warranty	3 years

### Installation Accessories



Suspended Rope



Connector



Splicing Method



Aluminum Profile

## Installation

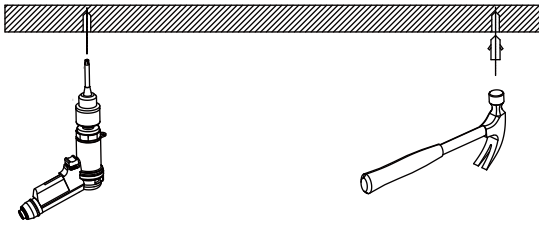

① Prepare the electric drill, hammer, stud;

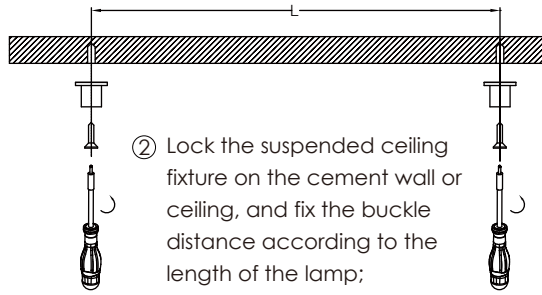

② Lock the suspended ceiling fixture on the cement wall or ceiling, and fix the buckle distance according to the length of the lamp;

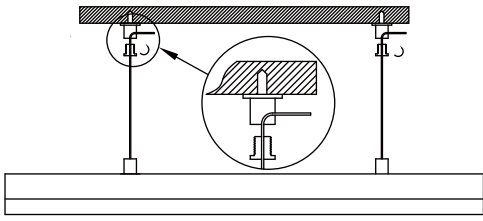

③ Lock the wire sling fixing parts, and fixed the installation length by adjust the wire sling;

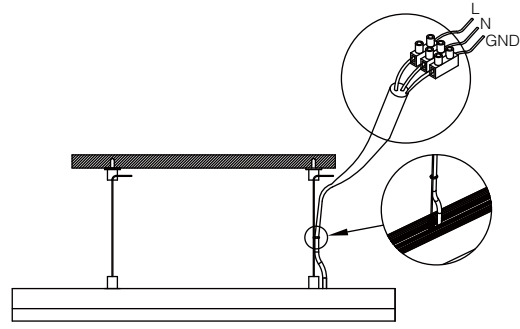

④ Connect the power supply and complete the installation.

## Packing

① Product

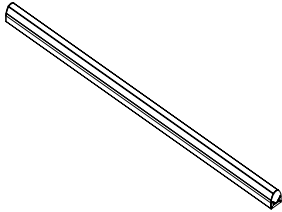

② Packing

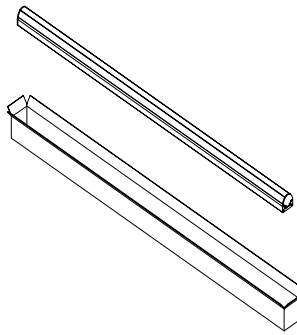

③ Sealing

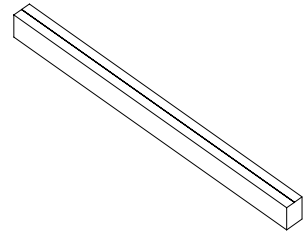

Model	HL-CA005-L12
Inner box	1237*70*100mm

Carton box	1252*365*215mm
QTY/Carton	10 PCS

## Notices

- 1.The power supply must be turned off before installation.
- 2.Make sure the product is mounted under the surface of the object to be installed, and finally turn on the power to light up.
- 3.This product is for indoor use only.
- 4.This product is warranted for 3 years and problems occur within 3 years (except for human factors and accidental factors), free maintenance.
- 5.The product is not responsible for damage caused by accidental factors or improper use.