





# Model: HL-GB009H-R02

Color(Optional):    
Sliver Black



## SIZE

Unit: mm    Color

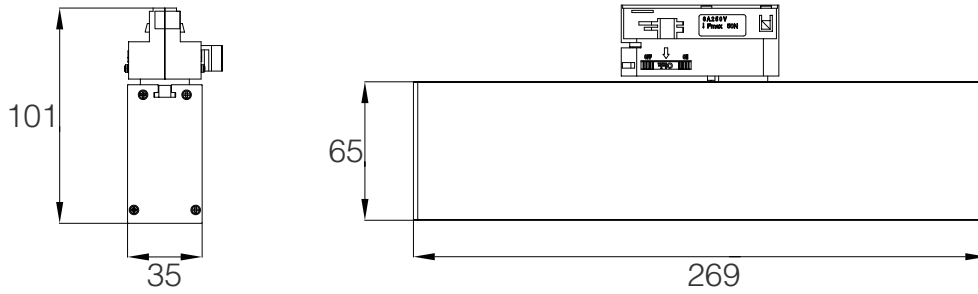

## Features

- The integrated design of lamp body, single pole and guide rail joint is adopted, and the appearance design is simple and elegant, beautiful and decent;
- The main material of the lamp is 6063-T5 aluminum, which has good heat dissipation performance, long service life and is more environmentally friendly;
- Using SMD LED light source, low power consumption, long life, good heat dissipation performance, energy saving and environmental protection;
- The guide rail joint can be rotated 0-330° horizontally and unilaterally;
- A variety of lens and reflector angles are optional, and different light distribution can be selected according to different scenes or requirements. anti-glare value UGR<16; soft and comfortable light, eye protection;
- Using a constant current built-in power supply, safe and reliable, no flickering lights
- Application: Various application scenarios such as shopping malls, offices, home decoration, exhibition halls, catering, etc.

## Accessories



Rail connector



A lens



B lens



C reflector



D lens

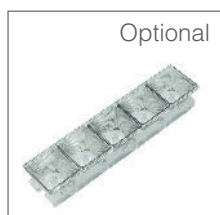

E lens



F lens

## PARAMETERS

Model	HL-GB009H-R02					
Cover	A lens	B lens	C reflector	D lens	E lens	F lens
Nominal Power	10W					
LM	1480lm	820lm	1370lm	1200lm	1070lm	780lm
Beam Angle	15° 24° 36° 48°	15° 24° 36° 48°	15° 30° 45°	15° 24° 36° 48°	Grid Flood 45°	Polarized light
Length(L*W*H)	L269*W35*H101mm					
Dimming	NO					
Rated Voltage	AC100-240V					
CRI	>70					
CCT	2700-6500k					
Warranty	3 years					
N.W	0.43KG					
Working Temperature	-20~+50℃					

## INSTRUCTIONS

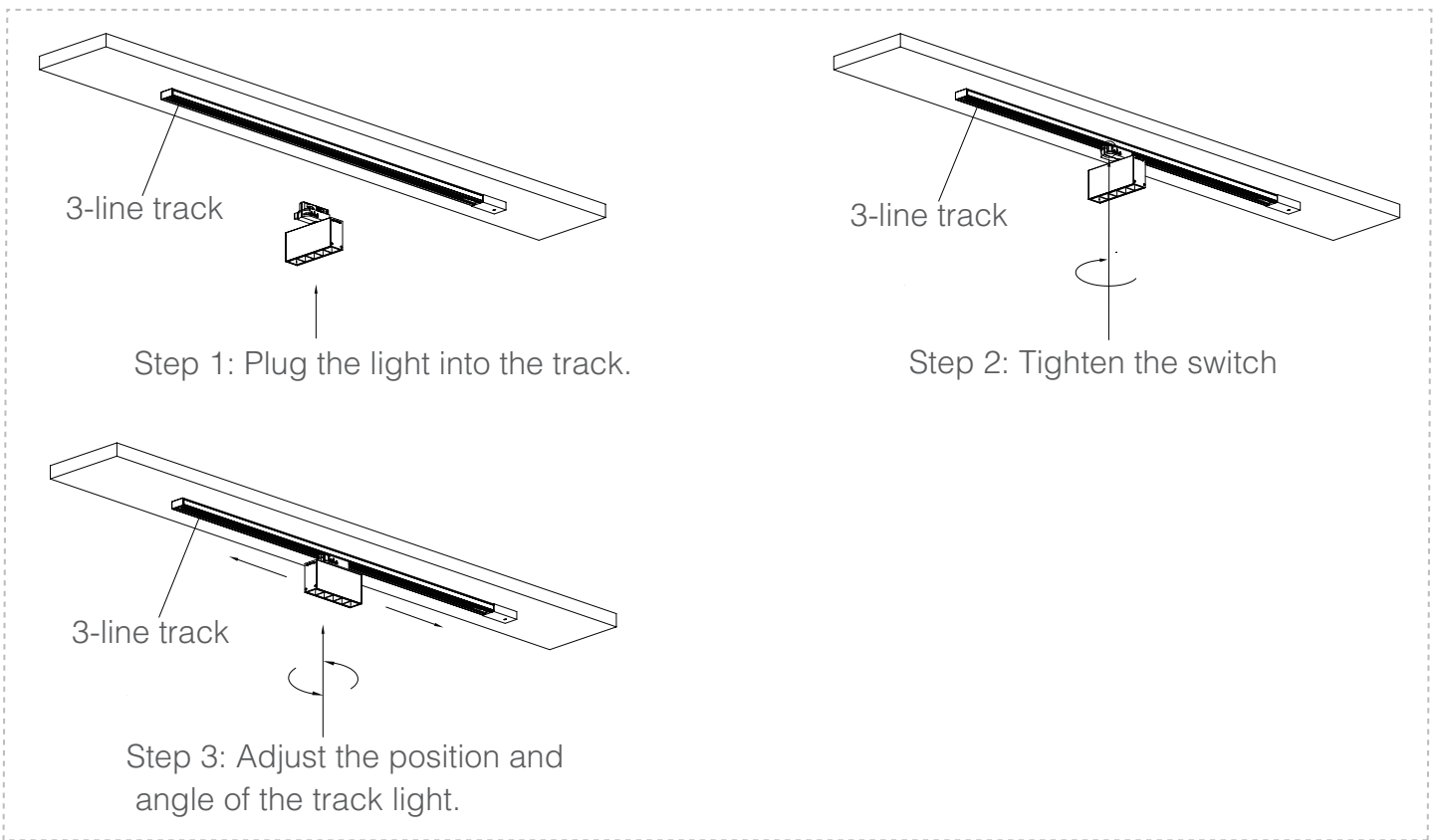

## ROTATION DIAGRAM

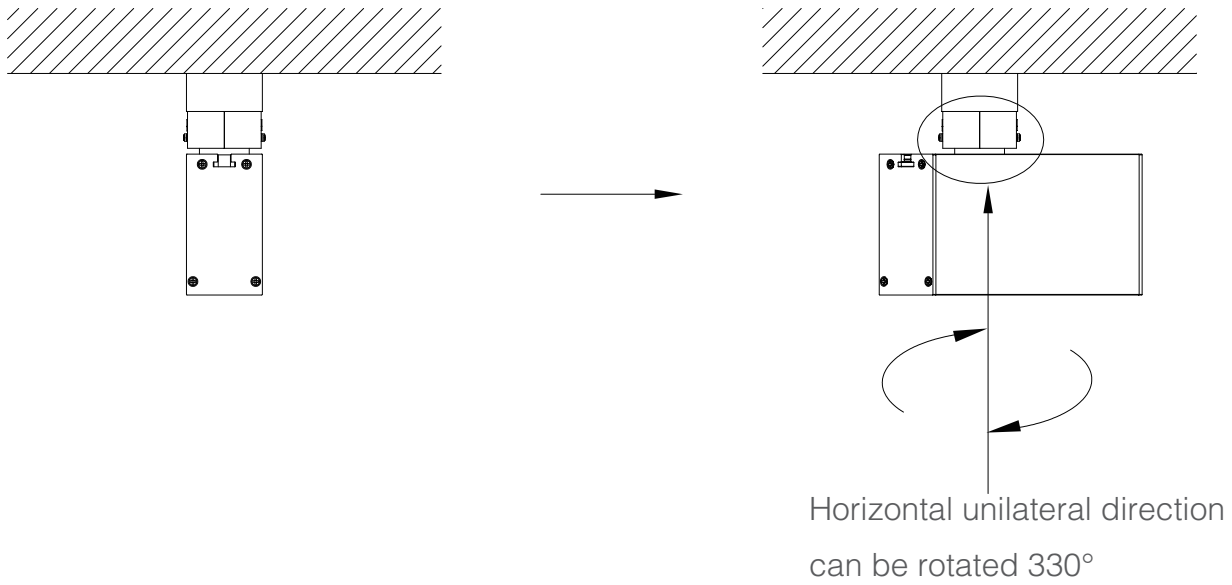

## APPLICATION PICTURE



## PACKAGING

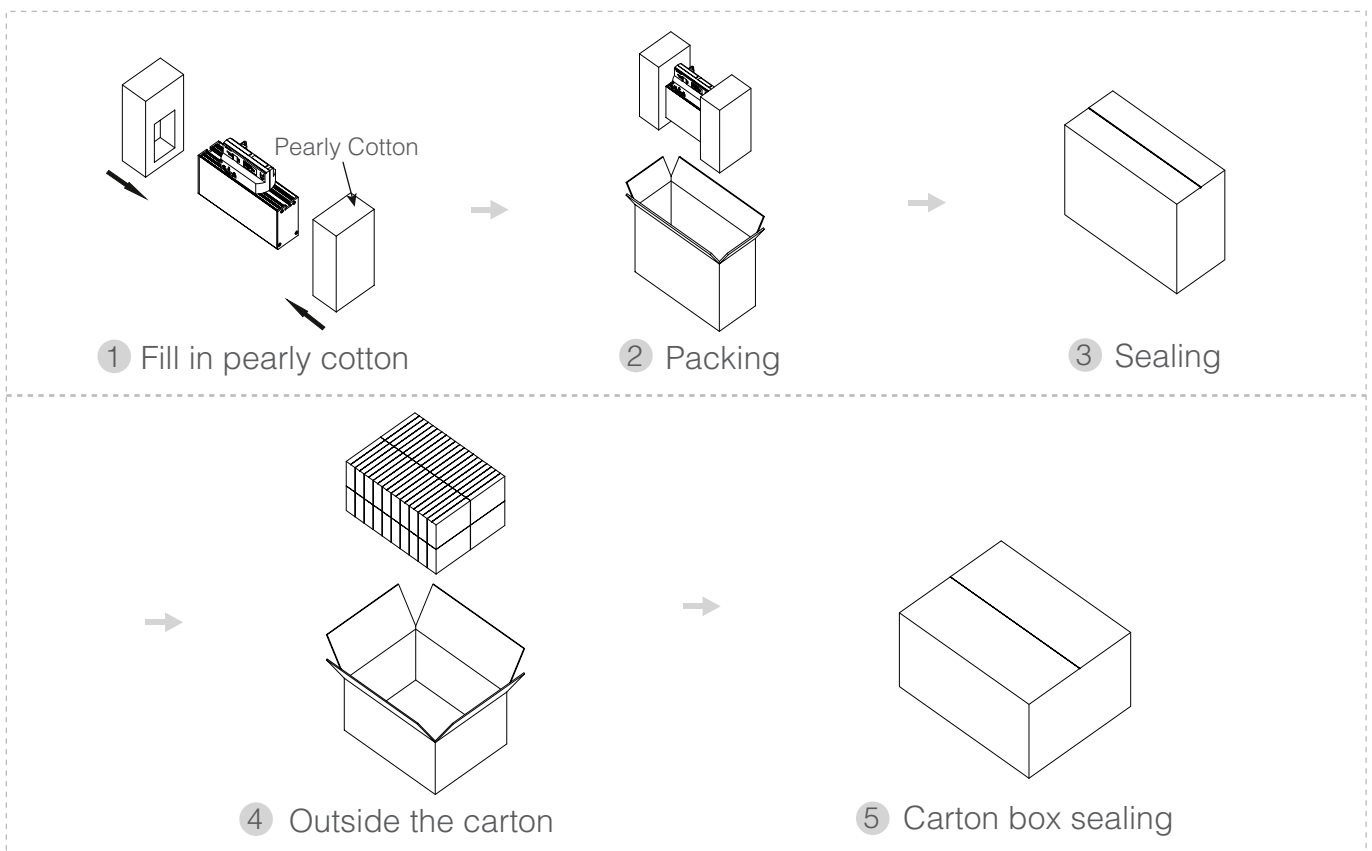

	Model	Inner box	Carton box	QTY/Carton
01	HL-GB009H-R02	310*75*140mm	765*325*295mm	20PCS

## NOTICES

- The power supply must be turned off before installation.
- Make sure the product is mounted under the surface of the object to be installed, and finally turn on the power to light up.
- This product is for indoor use only.
- This product is warranted for 3 years and problems occur within 3 years (except for human factors and accidental factors), free maintenance.
- The product is not responsible for damage caused by accidental factors or improper use.

H E L I A N

**Shenzhen  
Helian  
Electronics Co.,Ltd**

## Shenzhen Helian Electronics Co.,Ltd



3F, Tonggao building 2, Sanlian industrial area, Songbai Rd, Shiyan Town, Bao'an District, Shenzhen, Guangdong, China



**OUR EMAIL**

admin@hllcd.com



**OUR PHONE**

(86)-755-27606785



**OUR WEBSITE**

www.hllcd.com