

### Feature

- This Linear light have a simple, atmospheric design.
- Can be spliced
- High quality LED light source, energy saving and environmental protection.
- Anodized aluminum profile with good heat dissipation.
- Suitable for offices, conference rooms, supermarkets, home lighting, etc.

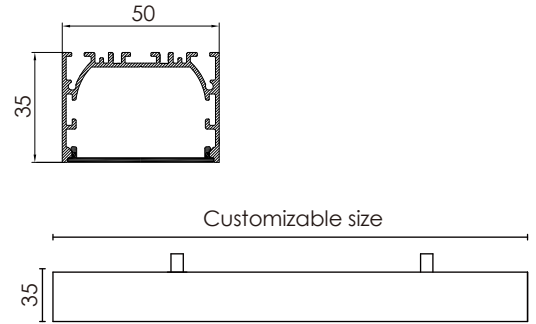

### Luminaire parameters

Name	HL-PA014-L12	L Type Connector	T Type Connector	+ Type Connector
Size	L1200*W50*H35mm	L150*W150*H35mm	L250*W150*H35mm	L250*W250*H35mm
Nominal Power	20W	/	/	/
Lm	2060lm	/	/	/
Input Voltage	AC100-240V			
Beam Angle	120°			
CCT	2700-6000k			
CRI	>80			
Protection Grade	IP40			
Certification	CE, RoHS			
Warranty	3 years			

### Installation Accessories



Aluminum Profile



Suspended Rope



Connector



Clip

## Installation

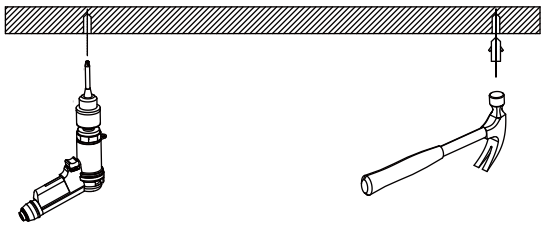

① Prepare the electric drill, hammer, stud;

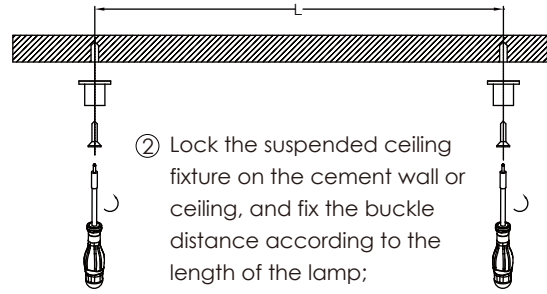

② Lock the suspended ceiling fixture on the cement wall or ceiling, and fix the buckle distance according to the length of the lamp;

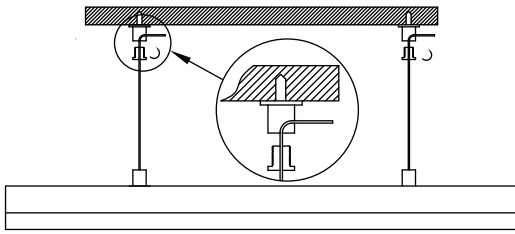

③ Lock the wire sling fixing parts, and fixed the installation length by adjust the wire sling;

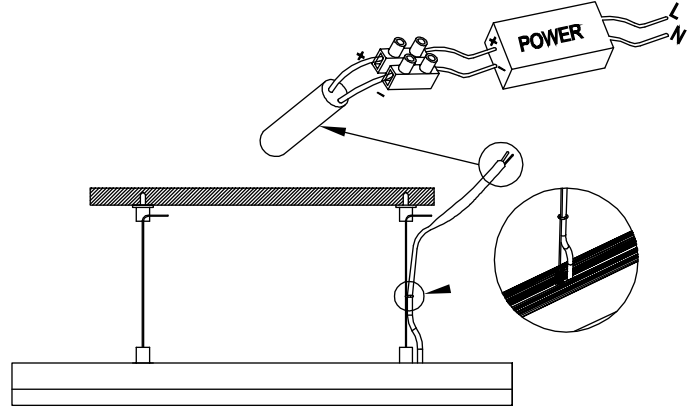

④ Connect the power supply and complete the installation.

## Splicing method

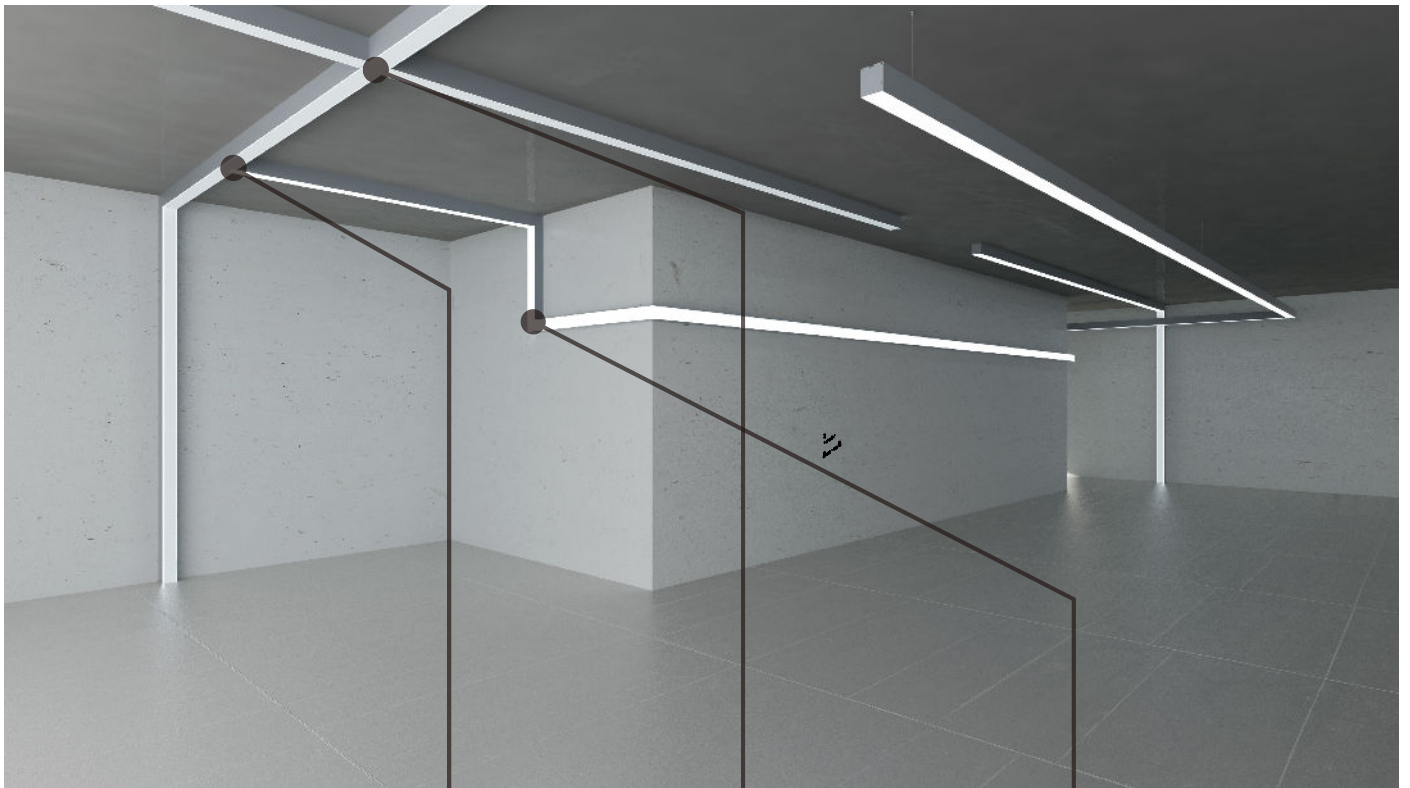

T Type Connector



+ Type Connector



L Type Connector

## Installation

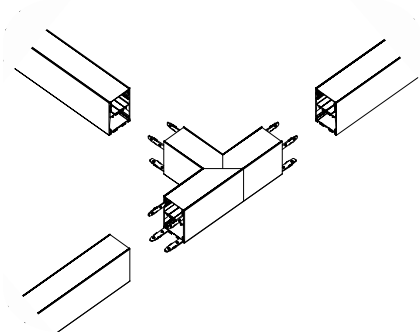

T Type Connector

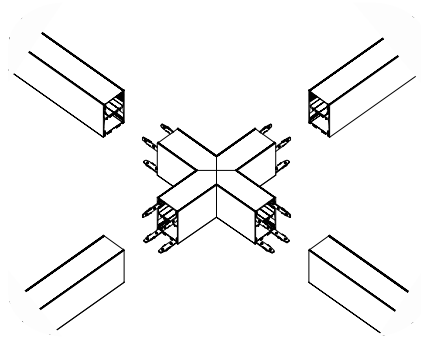

+ Type Connector

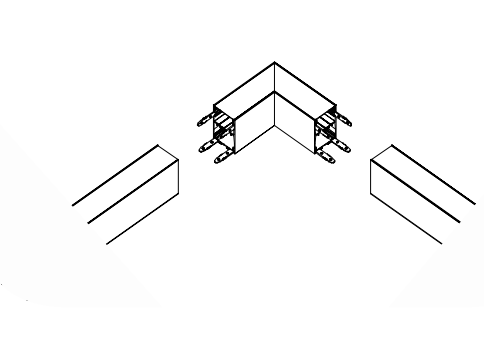

L Type Connector

## Packing

HL-PA014-L12

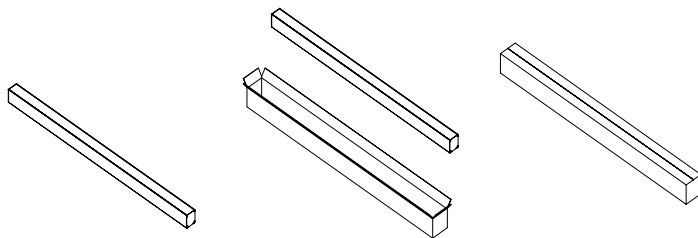

① Product

② Packing

③ Sealing

L Type Connector

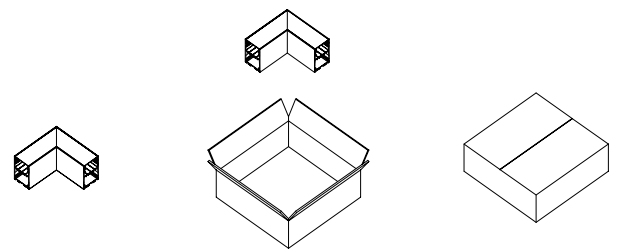

① Product

② Packing

③ Sealing

+ Type Connector

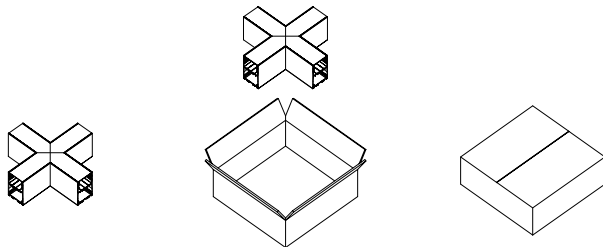

① Product

② Packing

③ Sealing

T Type Connector

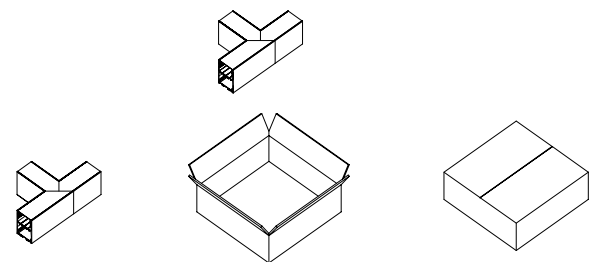

① Product

② Packing

③ Sealing

	Model	Inner box	Carton box	QTY/Carton
01	HL-PA014-L12	1230*85*60mm	1250*280*200mm	9PCS
02	L Type Connector	/	160*160*50mm	1PCS
03	T Type Connector	/	265*165*50mm	1PCS
04	+ Type Connector	/	265*265*50mm	1PCS

## Notices

- 1.The power supply must be turned off before installation.
- 2.Make sure the product is mounted under the surface of the object to be installed, and finally turn on the power to light up.
- 3.This product is for indoor use only.
- 4.This product is warranted for 3 years and problems occur within 3 years (except for human factors and accidental factors), free maintenance.
- 5.The product is not responsible for damage caused by accidental factors or improper use.