

UGR<19

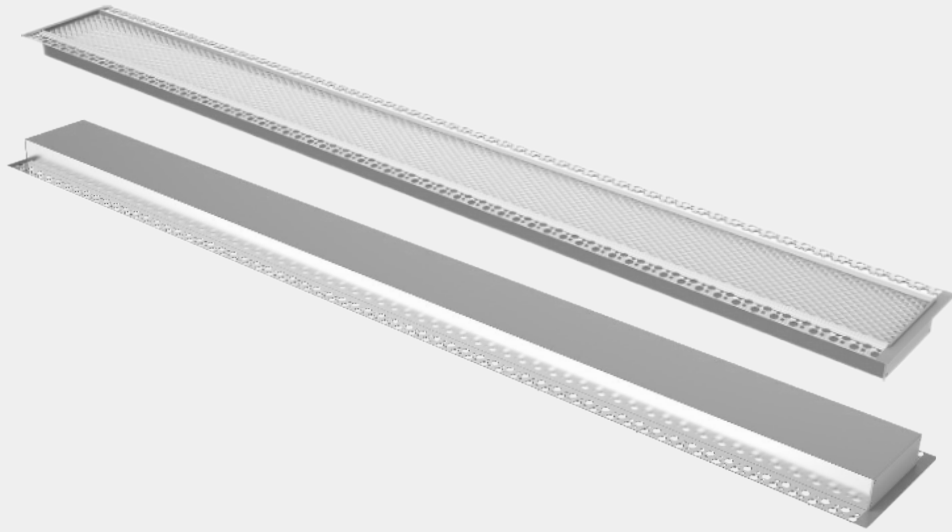

Feature

- Professional appearance design, simple and elegant.
- High quality, energy-efficient LED Lighting for environmental protection.
- Anodized aluminum profile with good heat sink.
- External power supply, no flicker.
- Optional cover for the lamp (PC diffuser cover / prism cover).
- Professional anti-glare prism diffusion plate, anti-glare value UGR < 19, light comfortable and soft, protect eyes.
- Application: offices, conference rooms, super markets, schools, home

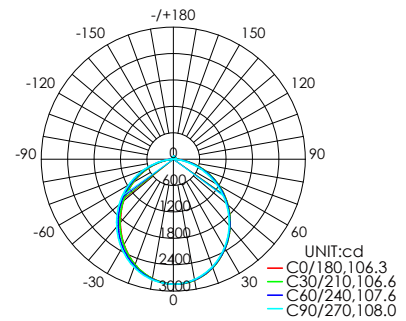
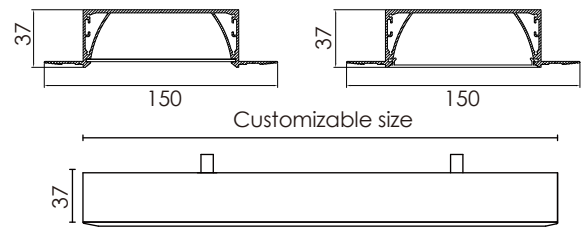

Luminaire parameters

Size	L2000*W150*H37mm
Lm	6800lm
Input Voltage	AC100-240V
Beam Angle	120°
Nominal Power	80W
CCT	2700-6500k
CRI	>80
Protection Grade	IP40
Certification	CE, RoHS
Warranty	3 years

Installation Accessories

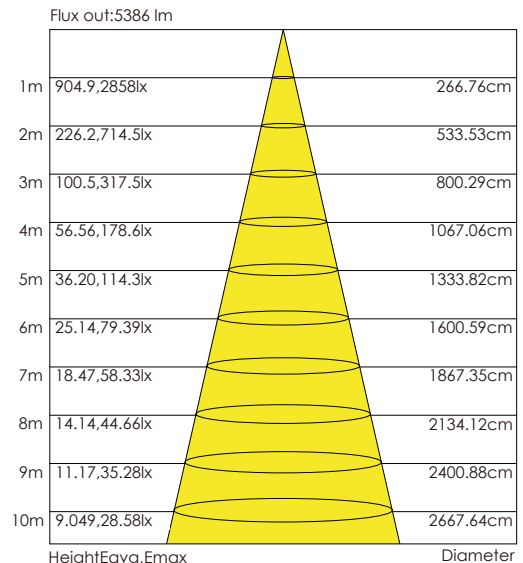

Installation

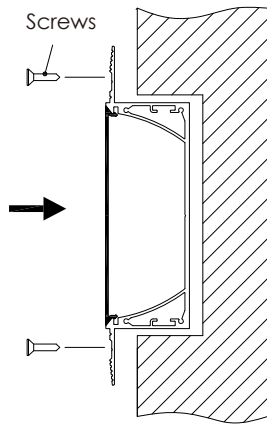

Step 1

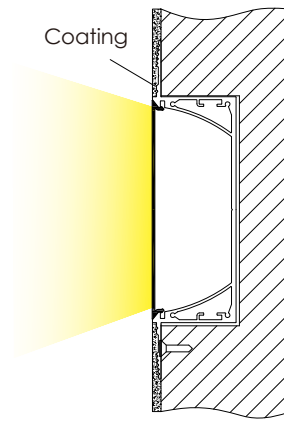

Step 2

Packing

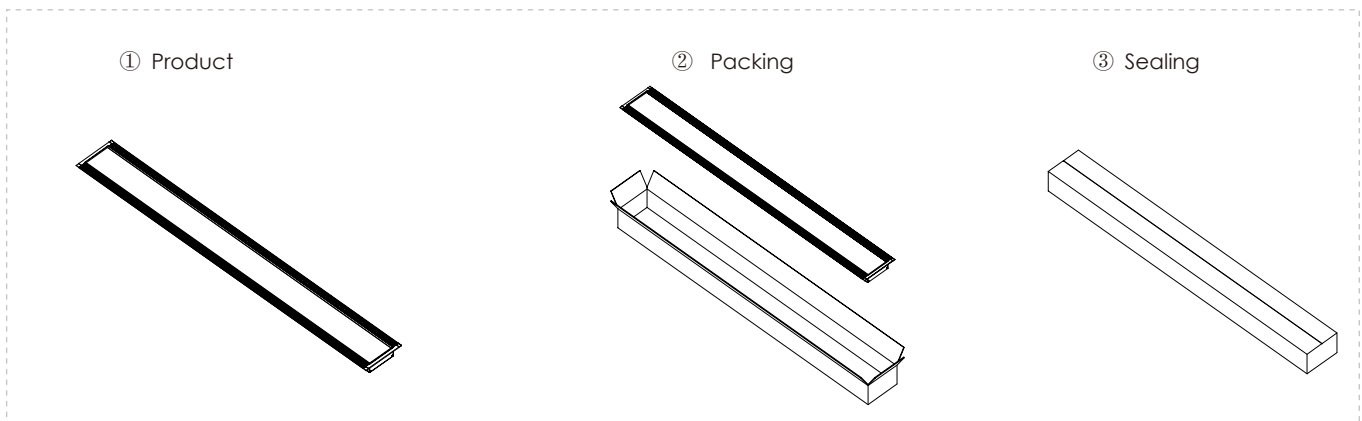

Model	HL-CA051-L20	Carton box	2065*605*205mm
Inner box	2050*195*95mm	QTY/Carton	6 PCS

Notices

- 1.The power supply must be turned off before installation.
- 2.Make sure the product is mounted under the surface of the object to be installed, and finally turn on the power to light up.
- 3.This product is for indoor use only.
- 4.This product is warranted for 3 years and problems occur within 3 years (except for human factors and accidental factors), free maintenance.
- 5.The product is not responsible for damage caused by accidental factors or improper use.